

T8 MS



follow us on:



WWW.BOBSPA.COM

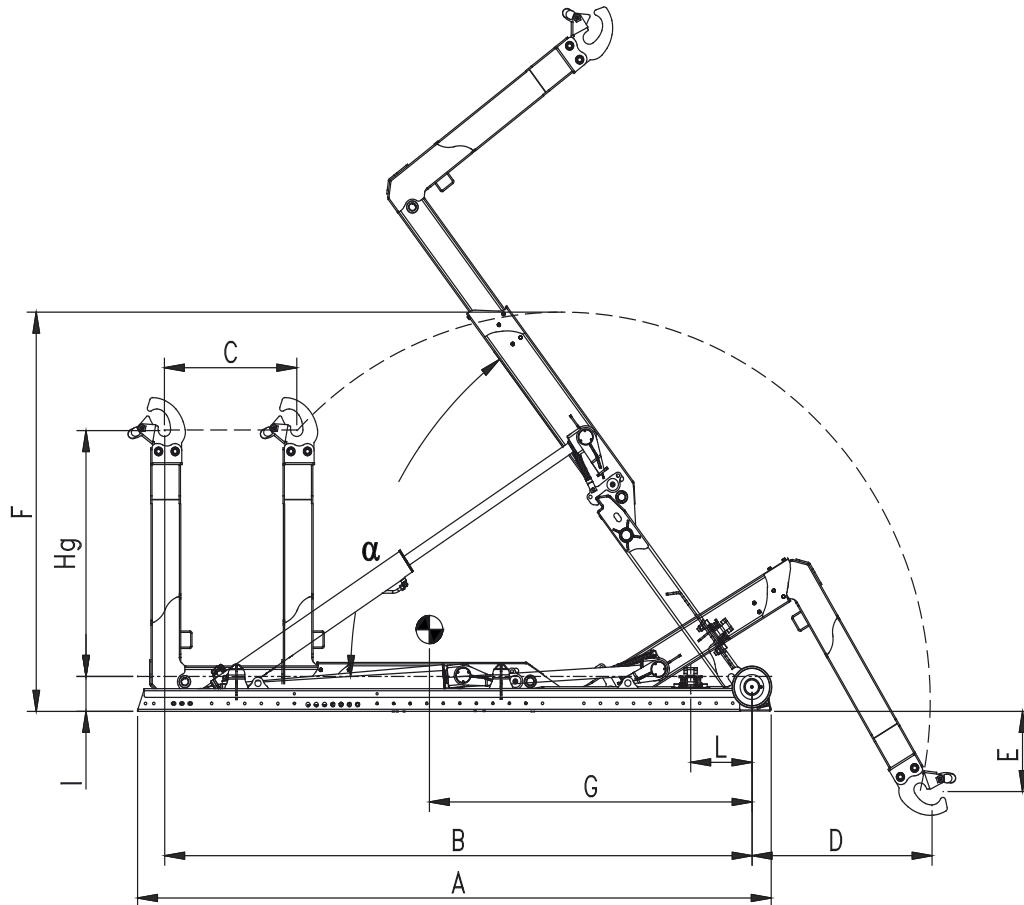

T8 MS Class 1

MODEL	HG	A	B	C	D	E	F	G	I	L	WEIGHT	α	CONTAINER	
													MIN	MAX
T8 XXC MS	900/920	3730	3350	700	940	70	1980	1820	200	270	1120 kg	55°	2800	3800
T8 XC MS	900/920	3830	3550	800	840	70	1980	1910	200	370	1145 kg	53°	3000	4000
T8 C MS	900/920	4030	3750	800	640	70	1980	2070	200	570	1170 kg	50°	3200	4200
T8 N MS	900/920	4330	4050	800	900	30	2240	2220	200	470	1210 kg	53°	3600	4600
T8 NL MS	900/920	4530	4250	800	700	30	2240	2350	200	670	1235 kg	49°	3800	4800
T8 L MS	900/920	4730	4450	800	500	30	2240	2480	200	670	1260 kg	45°	4000	5000

T8 MS Class 2

MODEL	HG	A	B	C	D	E	F	G	I	L	WEIGHT	α	CONTAINER	
													MIN	MAX
T8 XXC MS	1425/1570	3730	3350	700	1180	490	2280	1860	200	270	1145 kg	55°	2800	3800
T8 XC MS	1425/1570	3830	3550	800	1080	490	2280	1950	200	370	1170 kg	53°	3000	4000
T8 C MS	1425/1570	4030	3750	800	880	490	2280	2110	200	570	1195 kg	50°	3200	4200
T8 N MS	1425/1570	4330	4050	800	1160	490	2530	2260	200	470	1235 kg	53°	3600	4600
T8 NL MS	1425/1570	4530	4250	800	960	490	2530	2390	200	670	1260 kg	49°	3800	4800
T8 L MS	1425/1570	4730	4450	800	760	490	2530	2520	200	670	1285 kg	45°	4000	5000
T8 XL MS	1425/1570	5080	4600	1000	1480	100	2880	2480	220	500	1650 kg	55°	4000	5200